

# Wall Wine Rack Series

## 4ft 9 Column Bottom Stack

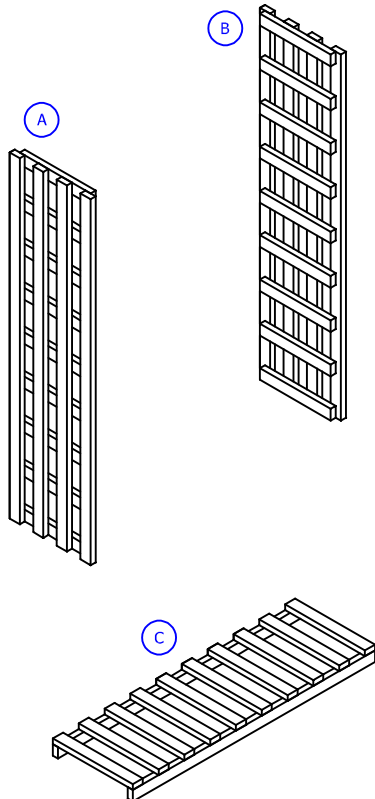
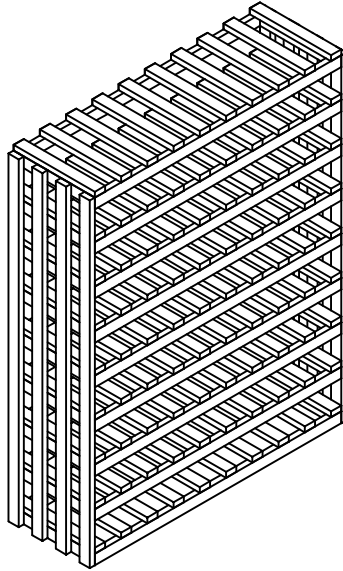

	A	B	C
1	<b>PARTS LIST</b>		
2	#	QTY	DESCRIPTION
3	A	1	Left Rack
4	B	1	Right Rack
5	C	9	Slat Shelf
6	*	1	Hardware Pack containing
7			Assortment of Brad Nails
8			
9			

1. Place the slat shelves loosely on the top and bottom. It helps if you have speed clamps to hold them in place temporarily.

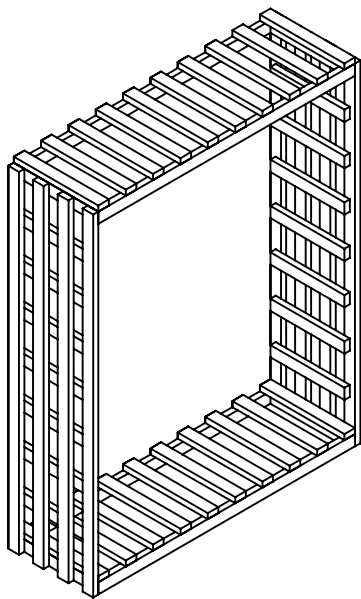

2. Nail only the bottom shelf to the side rail. Leave the top shelf to keep the spacing.

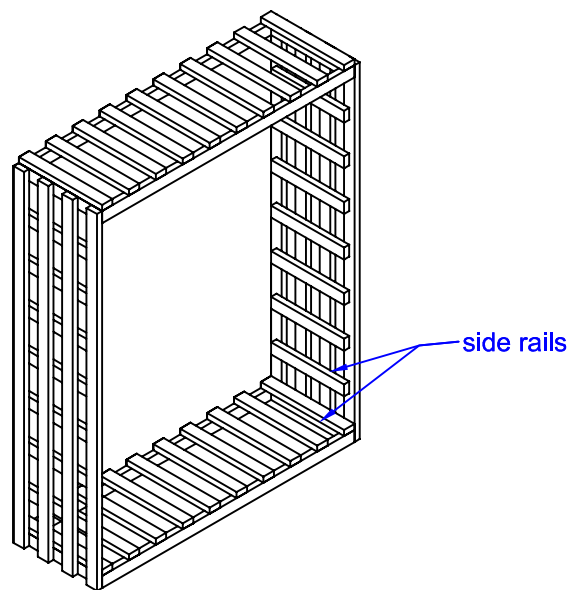

3. Keep adding shelves from the bottom up and nailing them on. Securing the top last.

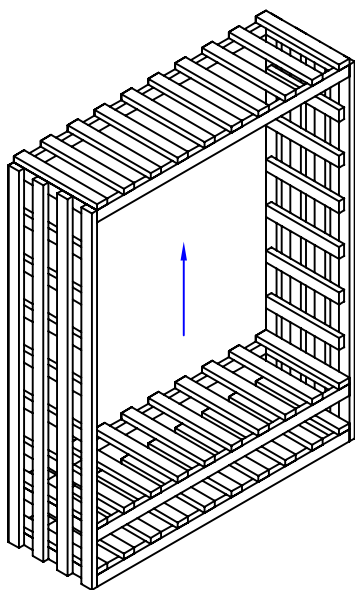

4. Flip the rack over and nail the back in the same fashion.

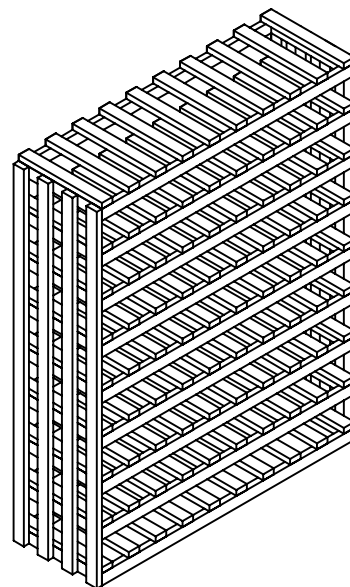

5. Middle Stack and Top Stack rack can be place directly on top.

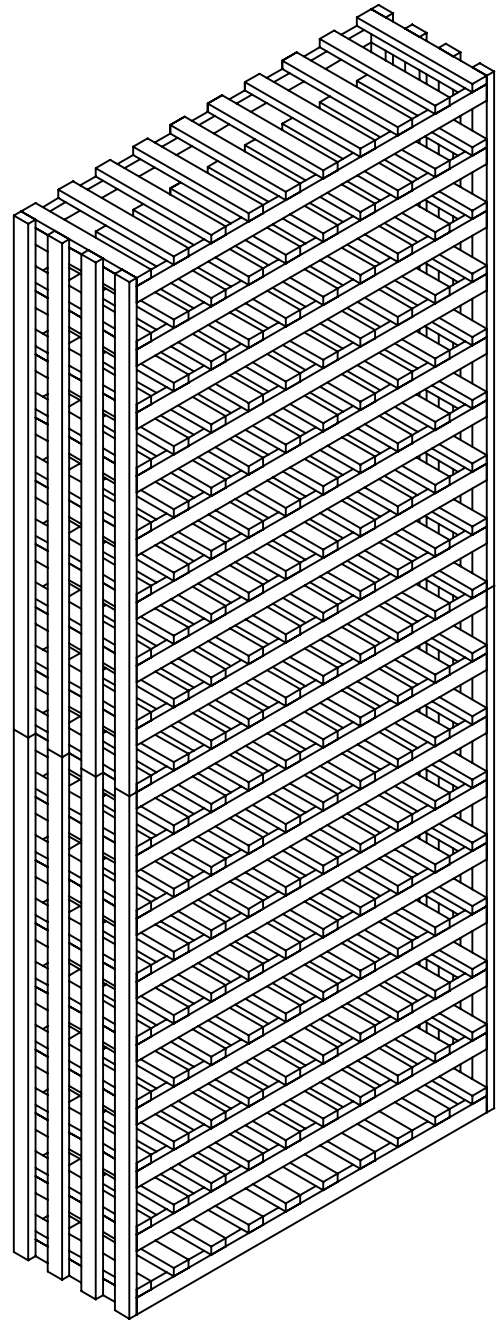
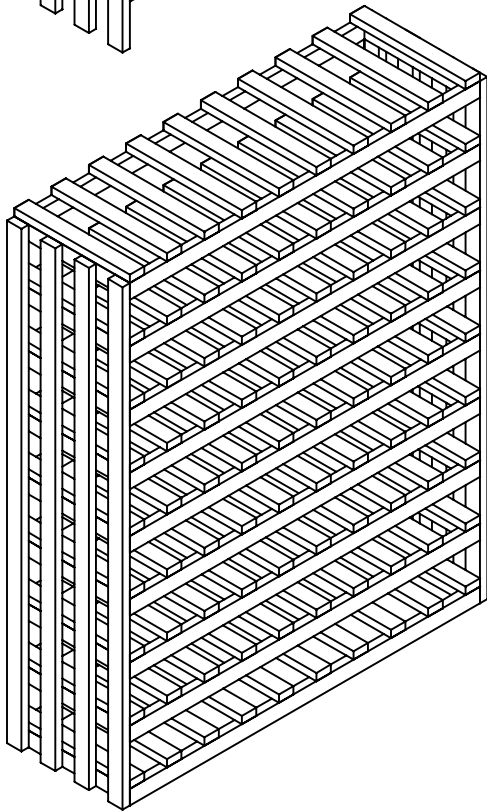
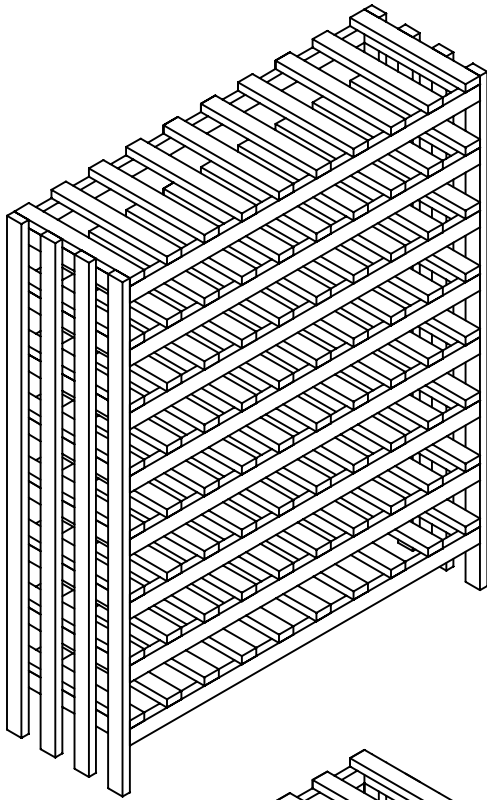

6. Anchor the racks to the wall using the recommended hardwares (not provided)

For Drywall and/or plywood walls we recommend securing the rack thru the back spacer bar into a stud in the wall using a 3" - #8 wood screw.

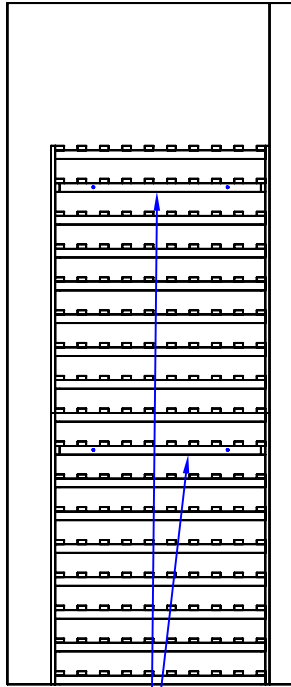

3" - #8 wood screw

For Concrete we recommend securing the rack using a 3" Tapcon screw thru a back spacer bar into the wall.

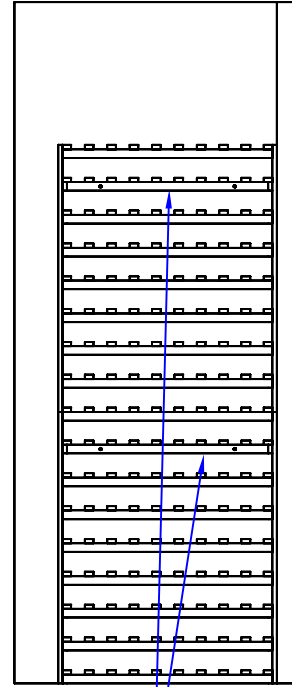

3" - Tapcon screw

For uneven surfaces, like brick, we recommend using a slotted "L" bracket that you secure to the post with a 5/8" screw and then use a Tapcon screw to secure to the wall.

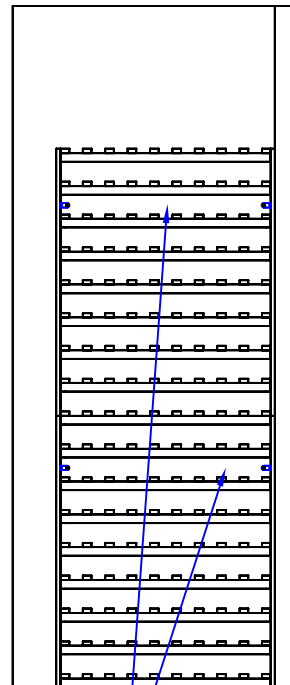

Slotted "L" bracket

# Wall Wine Rack Series

## 4ft 9 Column Top Stack

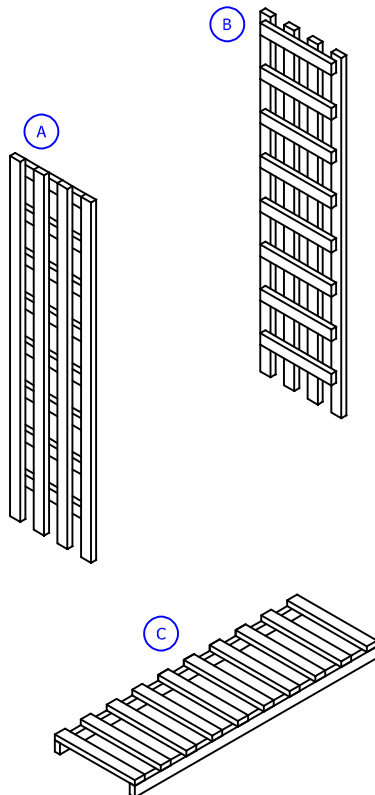
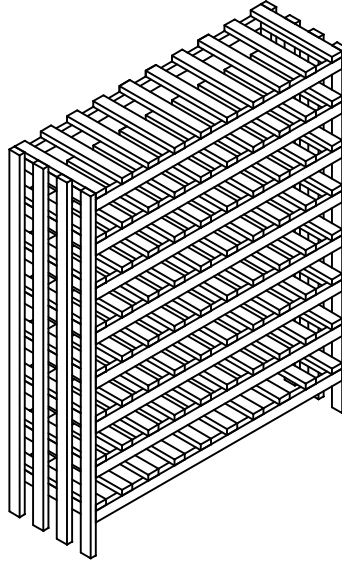

	A	B	C
1	PARTS LIST		
2	#	QTY	DESCRIPTION
3	A	1	Left Rack
4	B	1	Right Rack
5	C	8	Slat Shelf
6	*	1	Hardware Pack containing
7			Assortment of Brad Nails
8			
9			

1. Place the slat shelves loosely on the top and bottom. It helps if you have speed clamps to hold them in place temporarily.

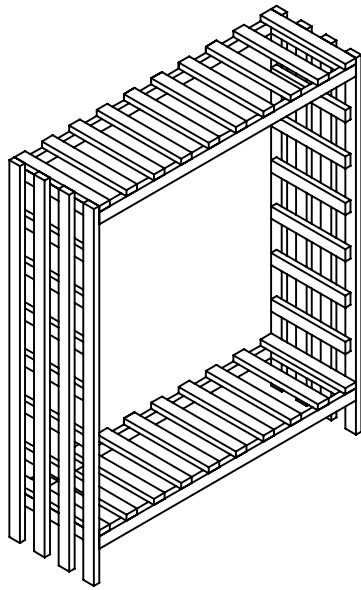

2. Nail only the bottom shelf to the side rail. Leave the top shelf to keep the spacing.

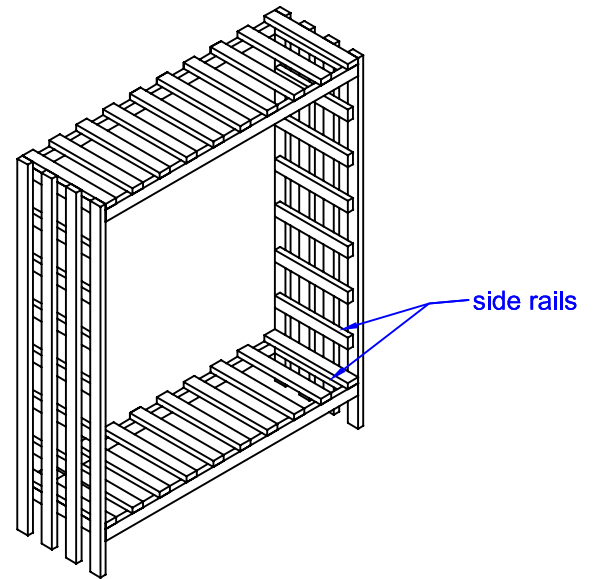

3. Keep adding shelves from the bottom up and nailing them on. Securing the top last.

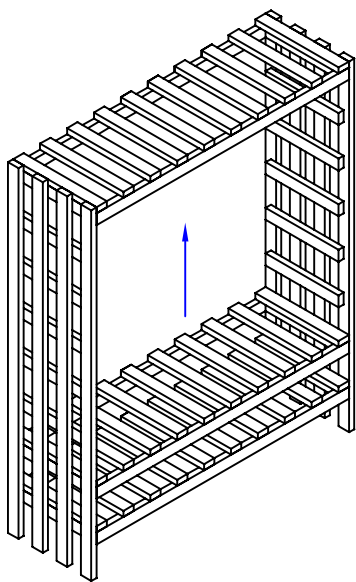

4. Flip the rack over and nail the back in the same fashion.

